

160A, 4-Phase, Single-Output Synchronous Buck Converter with Very Low DCR Inductors

DESCRIPTION

Demonstration circuit 2225A is a high efficiency, high density, 4-phase synchronous buck converter with a 4.5V to 14V input voltage range. It can supply up to 160A of load current with a 1.0V output. This demo board has two each LTC[®]3875EUJ feature-rich dual phase current mode synchronous buck controllers with very low DCR current sensing capability, on-chip drivers and remote output voltage sensing. This board is set up with 0.32mΩ DCR output inductors. The temperature compensation function offers an option for accurate current limit over a wide temperature range with DCR sensing. To shut down the converter, set the RUN pin voltage below 1V (SW1: OFF). Use JP1 jumper to select Burst Mode[®] operation, pulse skipping mode or forced continuous mode operation at light load. Switching frequency is preset at about 400kHz,

and it can be easily modified from 250kHz to 720kHz. An on-board dynamic circuit is also available for transient test.

The LTC3875 is suitable for inputs from 4.5V to 38V and outputs up to 5V. It can provide a high efficiency, high power density and versatile power solution for telecom and datacom systems, industrial and medical instruments, DC power distribution systems and computer systems. The LTC3875 is available in 40-lead 6mm × 6mm and 40-lead 5mm × 5mm QFN packages. Please see LTC3875 data sheet for more detailed information.

Design files for this circuit board are available at <http://www.linear.com/demo/DC2225A>

LT, LT, LTC, LTM, Linear Technology, the Linear logo and Burst Mode are registered trademarks of Linear Technology Corporation. All other trademarks are the property of their respective owners.

PERFORMANCE SUMMARY Specifications are at T_A = 25°C

PARAMETER	CONDITIONS	MIN	TYP	MAX	UNITS
Input Voltage Range		4.5		14	V
Output Voltage, V _{OUT}	V _{IN} = 4.5V to 14V, I _{OUT} = 0A to 160A	0.98	1.00	1.02	V
Maximum Output Current, I _{OUT}	V _{IN} = 4.5V to 14V, V _{OUT} = 1.0V		160		A
Typical Efficiency	V _{IN} = 12V, V _{OUT} = 1.0V, I _{OUT} = 160A		89.3		%
Peak Efficiency	V _{IN} = 12V, V _{OUT} = 1.0V, I _{OUT} = 100A		90.4		%
Typical Switching Frequency			400		kHz

QUICK START PROCEDURE

Demonstration circuit 2225A is easy to set up to evaluate the performance of the LTC3875EUJ. Refer to Figure 1 for the proper measurement equipment setup and follow the procedure below:

1. With power off, connect the input power supply to V_{IN} (4.5V to 14V) and GND (input return).
2. Connect the output load between V_{OUT} and GND (Initial load: no load).
3. Connect the DVMs to the input and output. Set default jumper position:

JP1	JP2	JP5	SW1
MODE	PHASMD1	BIAS	RUN
CCM	90°	OFF	ON

4. Turn on the input power supply and check for the proper output voltages. V_{OUT} should be $1.0V \pm 2\%$.
5. Once the proper output voltage is established, adjust the loads within the operating range and observe the output voltage regulation, ripple voltage and other parameters.

NOTE: When measuring the output or input voltage ripple, do not use the long ground lead on the oscilloscope probe. See Figure 2 for the proper scope probe technique. Short, stiff leads need to be soldered to the (+) and (-) terminals of an output capacitor. The probe's ground ring needs to touch the (-) lead and the probe tip needs to touch the (+) lead.

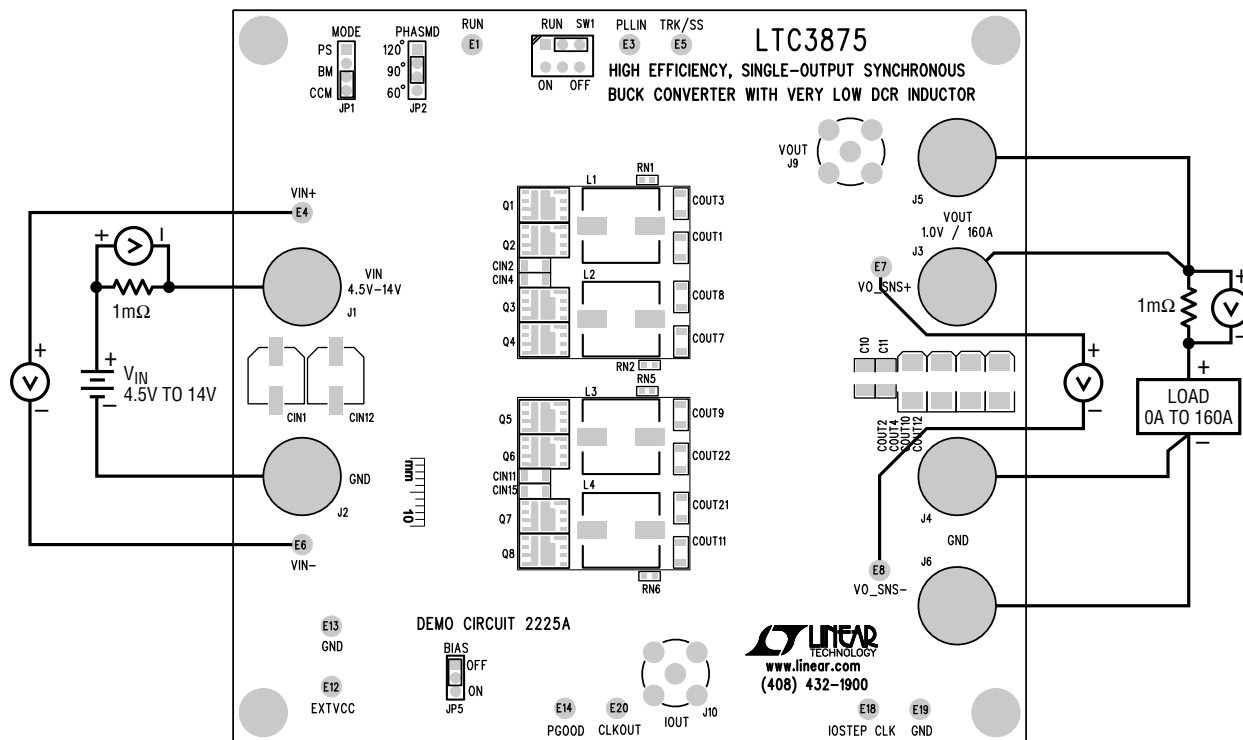

Figure 1. Proper Measurement Equipment Setup

QUICK START PROCEDURE

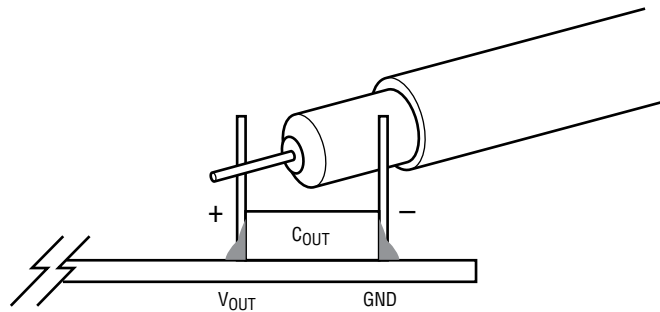

Figure 2. Measuring Output Voltage Ripple

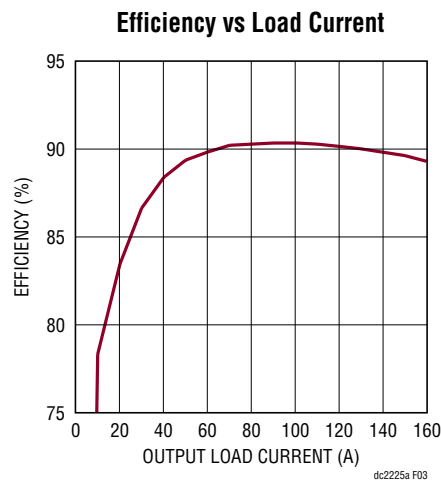

Figure 3. Efficiency vs Load Current at $V_{IN} = 12V$, $V_{OUT} = 1.0V$, $f_{SW} = 400kHz$

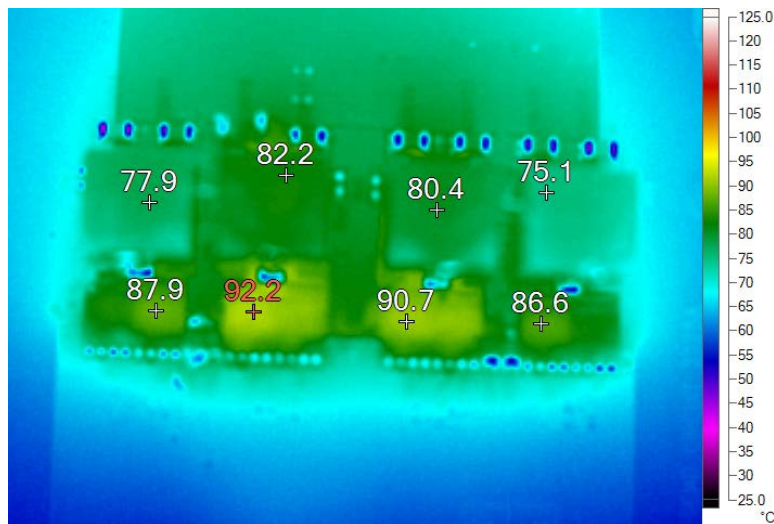

Figure 4. Thermal Performance at $V_{IN} = 12V$, $V_{OUT} = 1.0V$, $I_{OUT} = 160A$, 200LFM Forced Airflow, $T_A = 25^\circ C$

QUICK START PROCEDURE

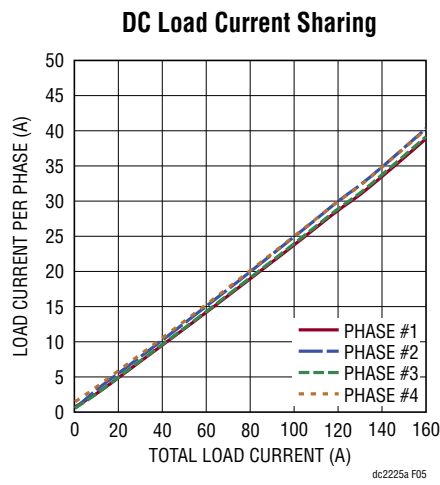

Figure 5. Current Sharing vs Load Current at $V_{IN} = 12V$, $V_{OUT} = 1.0V$, $f_{SW} = 400kHz$

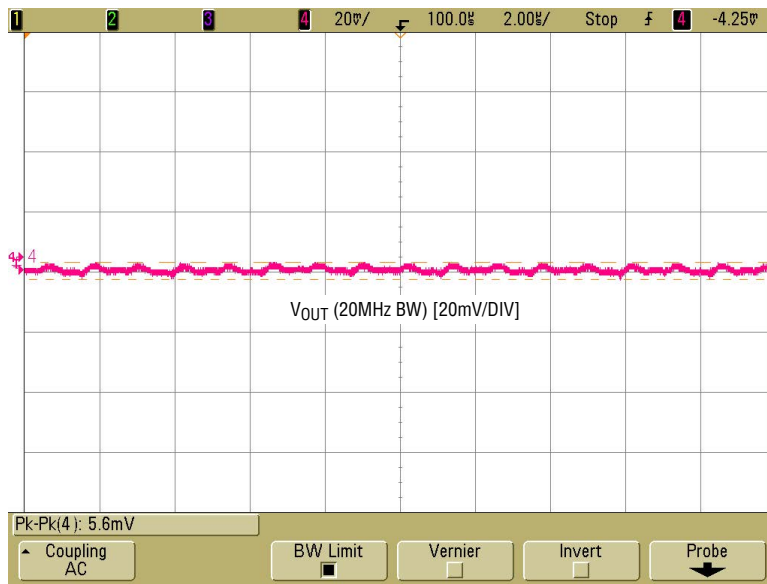

Figure 6. Output Voltage Ripple at $V_{IN} = 12V$, $V_{OUT} = 1.0V$, $I_{OUT} = 160A$, $f_{SW} = 400kHz$

QUICK START PROCEDURE

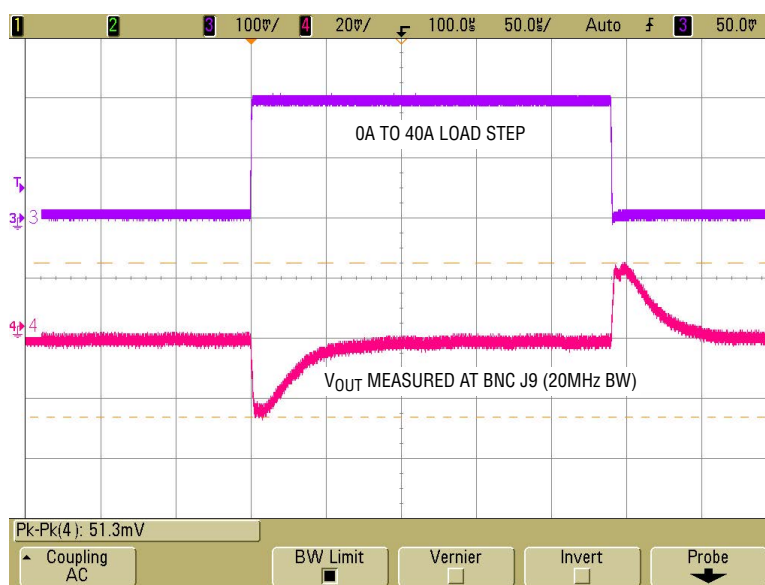

Figure 7. Transient Response at $V_{IN} = 12V$, $V_{OUT} = 1.0V$, $I_{OUT} = 0A \sim 40A$, $di/dt = 40A/\mu s$

PARTS LIST

ITEM	QTY	REFERENCE	PART DESCRIPTION	MANUFACTURER/PART NUMBER
Required Circuit Components				
1	4	CIN1, CIN10, CIN12, CIN13	CAP, OSCON, 270 μ F, 16V, 20%, E12	PANASONIC, 16SVPC270M
2	16	CIN2-CIN9, CIN11, CIN14-CIN20	CAP, 22 μ F, X7R, 16V, 20%, 1206	Taiyo Yuden, EMK316BB7226ML-T
3	8	COUT1, COUT3, COUT7, COUT8, COUT9, COUT11, COUT21, COUT22	CAP, 100 μ F, X5R, 6.3V, 20%, 1206	AVX, 12066D107MAT2A
4	8	C10, C11, C20, C21, C25, C41, C46, C50	CAP, 100 μ F, X5R, 6.3V, 20%, 1210	AVX, 12106D107MAT2A
5	11	COUT2, COUT4, COUT5, COUT6, COUT13, COUT15, COUT16, COUT17, COUT18, COUT19, COUT20	CAP, POSCAP, 470 μ F, 2.5V, 7343	PANASONIC, ETPF470M5H
6	5	C2, C7, C18, C28, C48	CAP, 0.1 μ F, X7R, 16V, 10%, 0603	AVX, 0603YC104KAT2A
7	8	C3, C4, C16, C19, C29, C30, C42, C47	CAP, 0.22 μ F, X5R, 25V, 10%, 0603	AVX, 06033D224KAT2A
8	1	C8	CAP, 10nF, X7R, 25V, 10%, 0603	AVX, 06033C103K4T2A
9	1	C9	CAP, 680pF, C0G, 25V, 10%, 0603	AVX, 06033A681FAT2A
10	2	C13, C44	CAP, 1 μ F, X5R, 25V, 10%, 0603	MURATA, GRM188R61E105KA12D
11	2	C22, C27	CAP, 1 μ F, X5R, 16V, 10%, 0603	AVX, 0603YD105KAT2A
12	1	C33	CAP, 1 μ F, X7R, 16V, 10%, 0805	MURATA, GRM21BR71C105KA01L
13	2	C14, C45	CAP, 4.7 μ F, X5R, 25V, 10%, 0805	TDK, C2012X5R1E475K
14	2	C31, C35	CAP, 10 μ F, X5R, 16V, 10%, 1210	AVX, 1210YD106KAT2A
15	1	C34	CAP, 0.22 μ F, X7R, 16V, 10%, 0805	AVX, 0805YC224KAT2A
16	1	C43	CAP, 47pF, X7R, 25V, 10%, 0603	AVX, 06033C470KAT2A

DEMO MANUAL DC2225A

PARTS LIST

ITEM	QTY	REFERENCE	PART DESCRIPTION	MANUFACTURER/PART NUMBER
17	2	R1, R14	RES., 20k, 1/10W, 1%, 0603	NIC, NRC06F2002TRF
18	5	R4, R17, R19, R23, R61	RES., 0 Ω , 1/10W, 0603	NIC, NRC06Z0TRF
19	4	R9, R10, R56, R57	RES., 2k, 1/10W, 1%, 0603	NIC, NRC06F2001TRF
20	4	R11, R34, R52, R63	RES., 3.57k, 1/10W, 1%, 0603	NIC, NRC06F3571TRF
21	4	R12, R29, R35, R62	RES., 715 Ω , 1/10W, 1%, 0603	NIC, NRC06F7150TRF
22	1	R13	RES., 13.3k, 1/10W, 1%, 0603	NIC, NRC06F1332TRF
23	1	R15	RES., 1.65k, 1/10W, 1%, 0603	NIC, NRC06F1651TRF
24	2	R16, R20	RES., 10 Ω , 1/10W, 1%, 0603	NIC, NRC06F10R0TRF
25	2	R18, R24	RES., 2.2 Ω , 1/10W, 1%, 0603	NIC, NRC06F2R20TRF
26	3	R28, R32, R73	RES., 100k, 1/10W, 1%, 0603	NIC, NRC06F1003TRF
27	7	R37, R40, R51, R53, R55, R59, R75	RES., 10k, 1/10W, 1%, 0603	NIC, NRC06F1002TRF
28	2	R43, R44	RES., 4.99k, 1/10W, 1%, 0603	NIC, NRC06F4991TRF
29	1	R54	RES., 34.8k, 1/10W, 1%, 0603	NIC, NRC06F3482TRF
30	1	R60	RES., SENSE, 0.005 Ω , 1%, 1W, 2512	PANASONIC, ERJM1WSF5MOU
31	4	D1, D2, D3, D4	DIODE, SCHOTTKY, SOD-323	CENTRAL SEMI., CMDSH-3TR
32	4	L1, L2, L3, L4	IND., 0.25 μ H	WURTH ELEKTRONIK, 744301025
33	8	Q1, Q2, Q3, Q4, Q5, Q6, Q7, Q8	XSTR., MOSFET, DUAL N-CH	INFINEON, BSG0811ND
34	2	Q20, Q21	XSTR., MOSFET, N-CH, 30V, TO-252	VISHAY, SUD50N03-09P-GE3
35	2	U1, U2	I.C., LTC3875EUJ#PBF, QFN 6mm x 6mm	LINEAR TECH., LTC3875EUJ#PBF
36	1	U3	I.C., LT1763CDE#PBF, 4mm X 3mm	LINEAR TECH., LT1763CDE#PBF

Additional Demo Board Circuit Components

1	0	C1, C5, C6, COUT10, COUT12, COUT14, C23, C24, C26, C32, C37, C38, C39, C40 (OPT)	OPTIONAL	
2	0	RN1, RN2, R2, R3, RN5, R5, RN6, R6, R7, R8, R22, R27, R31, R33, R36, R38, R39, R41, R42, R45, R46, R47, R48, R49, R50, R58, R64, R65, R66, R67, R68, R69, R70, R71(OPT)	OPTIONAL	

Hardware: For Demo Board Only

1	13	E1, E3-E8, E12-E14, E18-E20	TEST POINT, TURRET, .064" MTG. HOLE	MILL-MAX, 2308-2-00-80-00-00-07-0
2	6	J1-J6	STUD, TESTPIN	PEM, KFH-032-10
3	12	J1-J6(X2)	NUT, BRASS 10-32	ANY #10-32
4	6	J1-J6	RING, LUG #10	KEYSTONE, 8205, #10
5	6	J1-J6	WASHER, TIN PLATED BRASS	ANY #10
6	2	JP1, JP2	CONN., HEADER, 1X4, 2mm	SAMTEC, TMM-104-02-L-S
7	1	JP5	CONN., HEADER, 1X3, 2mm	SAMTEC, TMM103-02-L-S
8	1	SW1	SWITCH, SLIDE DPDT 6VDC 0.3A PCMNT	C&K., JS202011CQN
9	2	J9, J10	CONN, BNC 5PINS	CONNEX, 112404
10	3	XJP1, XJP2, XJP5	SHUNT, 2mm	SAMTEC, 2SN-BK-G

SCHEMATIC DIAGRAM

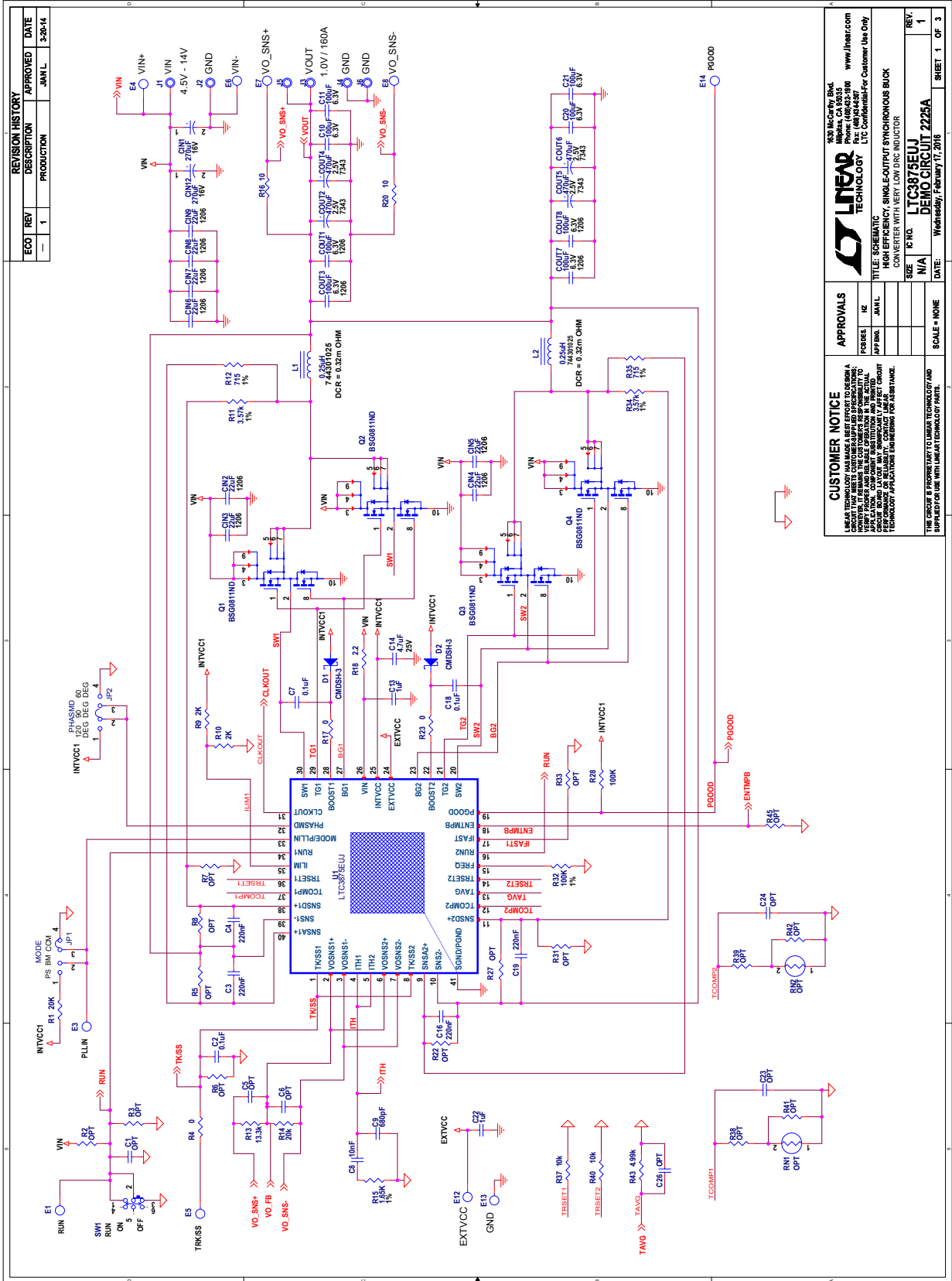

REVISION HISTORY		
ECO	REV	DESCRIPTION
-	1	PRODUCTION

APPROVED DATE		
APPROVED	DATE	
JANIL	3-20-14	

CUSTOMER NOTICE
 LINEAR TECHNOLOGY MAKES A BEST EFFORT TO DESIGN A CIRCUIT THAT MEETS CUSTOMER-SPECIFIED OPERATING CONDITIONS. LINEAR TECHNOLOGY DOES NOT WARRANT THE ACTUAL PERFORMANCE OF ANY DEVICE OR SYSTEM IN THE FIELD. CUSTOMER SHOULD VERIFY THE ACTUAL PERFORMANCE OF ANY DEVICE OR SYSTEM IN THE FIELD. LINEAR TECHNOLOGY ASSUMES NO LIABILITY FOR DAMAGES OF ANY KIND, INCLUDING CONSEQUENTIAL DAMAGES, ARISING FROM THE USE OF ANY LINEAR TECHNOLOGY PRODUCT IN ANY MANNER.

APPROVALS
 DESIGNER: [Signature]
 CHECKED: [Signature]
 DATE: [Date]

SCALE - NONE

REV. 1

DATE: Wednesday, February 17, 2016

SHEET 1 OF 3

LINEAR TECHNOLOGY
 9350 McCarty Blvd.
 Milpitas, CA 95035-5080
 Fax: (408)441-8700
 www.linear.com

LTIC8875EUJ
 SINGLE-OUTPUT SYNCHRONOUS BUCK CONVERTER WITH A VERY LOW-DISC INDUCTOR

DEMO MANUAL DC2225A

SCHEMATIC DIAGRAM

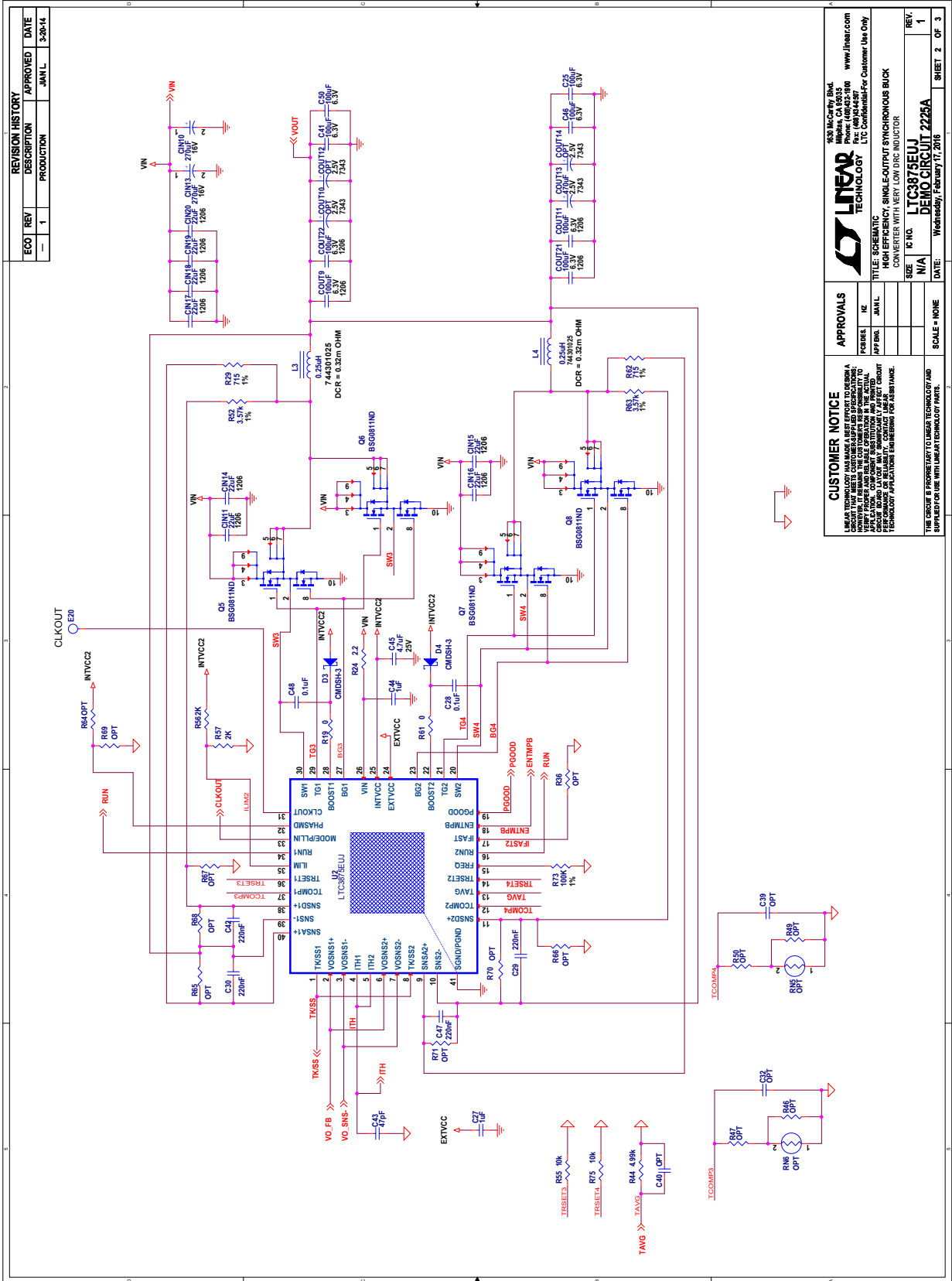

REVISION HISTORY			
ECO	REV	DESCRIPTION	APPROVED DATE
-	1	PRODUCTION	JAN11 3-20-14

CUSTOMER NOTICE
 LINEAR TECHNOLOGY MAKES A BEST EFFORT TO DESIGN A CIRCUIT THAT MEETS CUSTOMER SPECIFICATIONS. HOWEVER, LINEAR TECHNOLOGY DOES NOT WARRANT THE ACTUAL PERFORMANCE OF ANY CIRCUIT OR THE ACTUAL RESULTS OF ANY CIRCUIT. CUSTOMER SHOULD CONSULT WITH LINEAR TECHNOLOGY APPLICATION ENGINEERING FOR ASSISTANCE.

APPROVALS

DESIGNER	IKZ
APP'NR	JMH

SCALE - NONE

DATE: Wednesday, February 17, 2010

1630 McCarty Blvd.
LINEAR TECHNOLOGY
 www.linear.com
 Phone: (978) 683-2266
 Fax: (978) 683-2299
 LTC Confidential-For Customer Use Only

TITLE: CUSTOMER
HEAVY DUTY SINGLE-OUTPUT SYNCHRONOUS BUCK CONVERTER WITH VERY LOW DCR INDUCTOR

REV: 1
SCALE: N/A
DATE: Wednesday, February 17, 2010
SHEET 2 OF 3

SCHEMATIC DIAGRAM

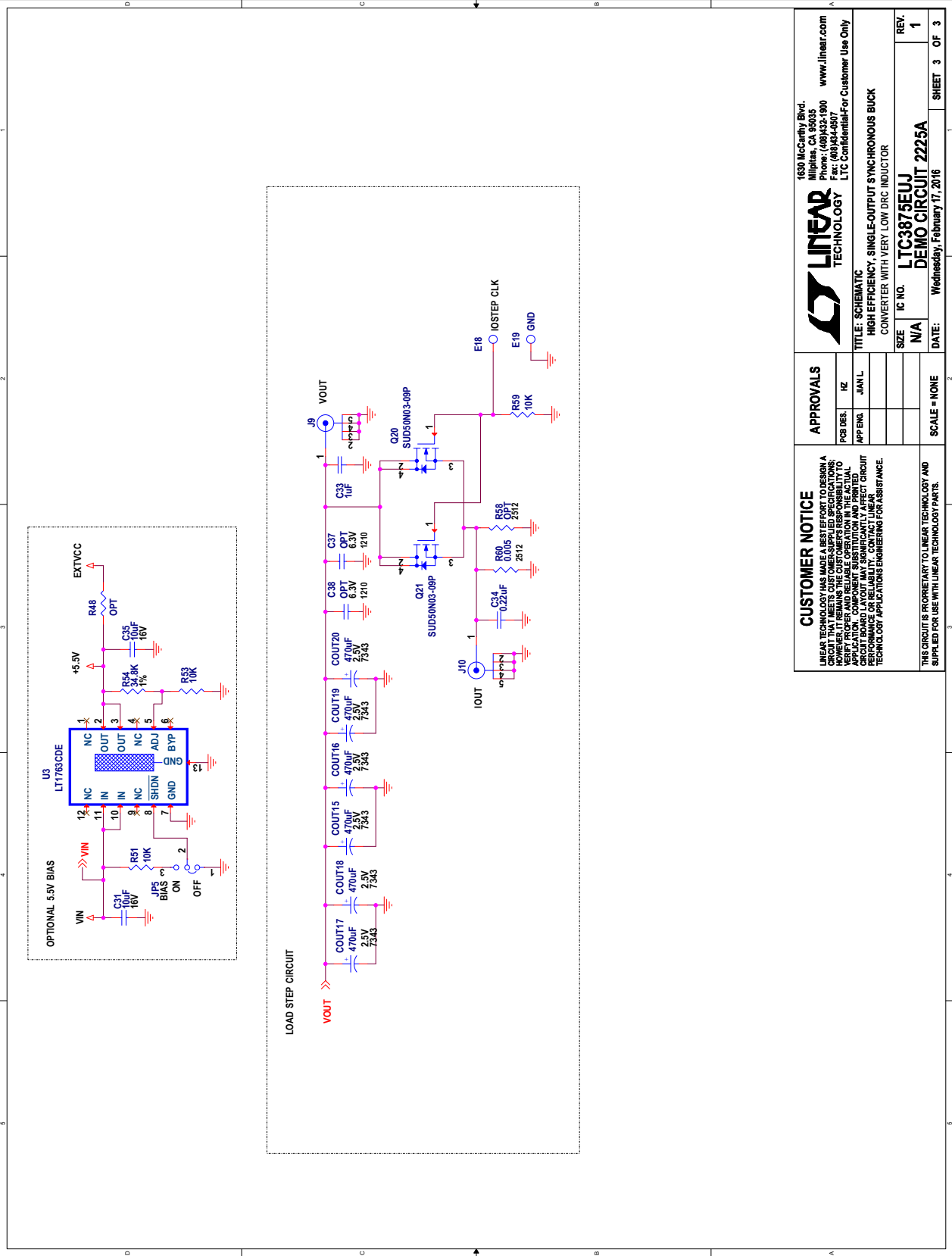

CUSTOMER NOTICE		APPROVALS	
<p>LINEAR TECHNOLOGY HAS MADE A BEST EFFORT TO DESIGN A CIRCUIT THAT MEETS CUSTOMER-SUPPLIED SPECIFICATIONS. LINEAR TECHNOLOGY DOES NOT WARRANT THE ACTUAL PERFORMANCE OF ANY COMPONENT OR THE ACTUAL PERFORMANCE OF THE COMPLETE CIRCUIT. CUSTOMER MUST VERIFY PROPER AND RELIABLE OPERATION IN THE ACTUAL APPLICATION. COMPONENT SUBSTITUTION AND PRINTED CIRCUIT BOARD MANUFACTURING VARIATIONS MAY AFFECT CIRCUIT PERFORMANCE OR RELIABILITY. CONTACT LINEAR TECHNOLOGY APPLICATIONS ENGINEERING FOR ASSISTANCE.</p>		<p>PCB DES. HZ</p> <p>APP ENGR. JAN L</p> <p>SCALE = NONE</p>	
<p>LINEAR TECHNOLOGY HAS MADE A BEST EFFORT TO DESIGN A CIRCUIT THAT MEETS CUSTOMER-SUPPLIED SPECIFICATIONS. LINEAR TECHNOLOGY DOES NOT WARRANT THE ACTUAL PERFORMANCE OF ANY COMPONENT OR THE ACTUAL PERFORMANCE OF THE COMPLETE CIRCUIT. CUSTOMER MUST VERIFY PROPER AND RELIABLE OPERATION IN THE ACTUAL APPLICATION. COMPONENT SUBSTITUTION AND PRINTED CIRCUIT BOARD MANUFACTURING VARIATIONS MAY AFFECT CIRCUIT PERFORMANCE OR RELIABILITY. CONTACT LINEAR TECHNOLOGY APPLICATIONS ENGINEERING FOR ASSISTANCE.</p>		<p>1630 McCarthy Blvd. Milpitas, CA 95035 Phone: (408)432-1900 www.linear.com Fax: (408)434-0907 LTC Confidential-For Customer Use Only</p>	
<p>TITLE: SCHEMATIC HIGH EFFICIENCY, SINGLE-OUTPUT SYNCHRONOUS BUCK CONVERTER WITH VERY LOW DRC INDUCTOR</p>		<p>SIZE IC NO. LTC3875EUJ</p>	
<p>DATE: Wednesday, February 17, 2016</p>		<p>REV. 1</p>	
<p>SHEET 3 OF 3</p>		<p>DEMO CIRCUIT 2225A</p>	

DEMO MANUAL DC2225A

DEMONSTRATION BOARD IMPORTANT NOTICE

Linear Technology Corporation (LTC) provides the enclosed product(s) under the following **AS IS** conditions:

This demonstration board (DEMO BOARD) kit being sold or provided by Linear Technology is intended for use for **ENGINEERING DEVELOPMENT OR EVALUATION PURPOSES ONLY** and is not provided by LTC for commercial use. As such, the DEMO BOARD herein may not be complete in terms of required design-, marketing-, and/or manufacturing-related protective considerations, including but not limited to product safety measures typically found in finished commercial goods. As a prototype, this product does not fall within the scope of the European Union directive on electromagnetic compatibility and therefore may or may not meet the technical requirements of the directive, or other regulations.

If this evaluation kit does not meet the specifications recited in the DEMO BOARD manual the kit may be returned within 30 days from the date of delivery for a full refund. **THE FOREGOING WARRANTY IS THE EXCLUSIVE WARRANTY MADE BY THE SELLER TO BUYER AND IS IN LIEU OF ALL OTHER WARRANTIES, EXPRESSED, IMPLIED, OR STATUTORY, INCLUDING ANY WARRANTY OF MERCHANTABILITY OR FITNESS FOR ANY PARTICULAR PURPOSE. EXCEPT TO THE EXTENT OF THIS INDEMNITY, NEITHER PARTY SHALL BE LIABLE TO THE OTHER FOR ANY INDIRECT, SPECIAL, INCIDENTAL, OR CONSEQUENTIAL DAMAGES.**

The user assumes all responsibility and liability for proper and safe handling of the goods. Further, the user releases LTC from all claims arising from the handling or use of the goods. Due to the open construction of the product, it is the user's responsibility to take any and all appropriate precautions with regard to electrostatic discharge. Also be aware that the products herein may not be regulatory compliant or agency certified (FCC, UL, CE, etc.).

No License is granted under any patent right or other intellectual property whatsoever. **LTC assumes no liability for applications assistance, customer product design, software performance, or infringement of patents or any other intellectual property rights of any kind.**

LTC currently services a variety of customers for products around the world, and therefore this transaction **is not exclusive**.

Please read the DEMO BOARD manual prior to handling the product. Persons handling this product must have electronics training and observe good laboratory practice standards. **Common sense is encouraged.**

This notice contains important safety information about temperatures and voltages. For further safety concerns, please contact a LTC application engineer.

Mailing Address:

Linear Technology
1630 McCarthy Blvd.
Milpitas, CA 95035

Copyright © 2004, Linear Technology Corporation